

SLIDING DOOR TRACK PROFILES

CROSS SECTIONS WITH DIMENSIONS AND CAPACITIES

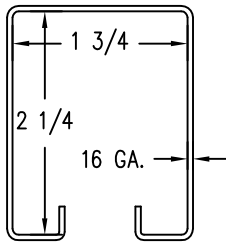

No. 31
400 lb. Capacity
Page 8

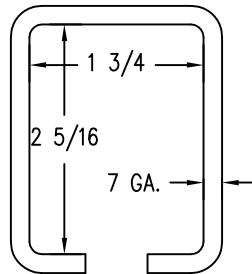

No. 2035
600 lb. Capacity
Page 14

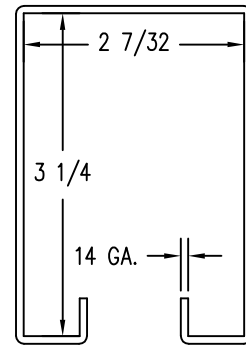

No. 232
600 lb. Capacity
Page 11

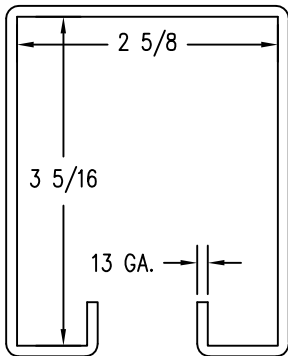

No. 330
800 lb. Capacity
Page 17

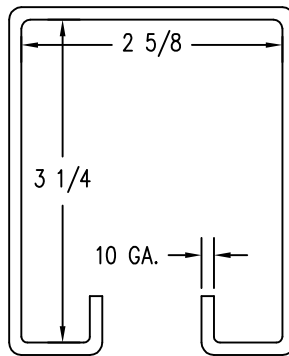

No. 376
1000 lb. Capacity
Page 20

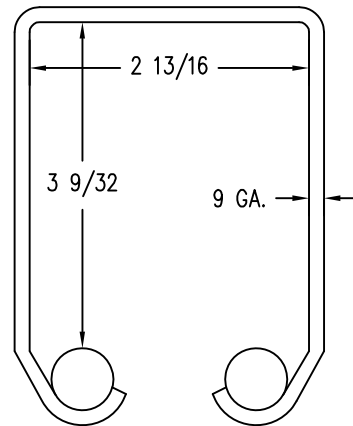

No. 888
5000 lb. Capacity
Page 23

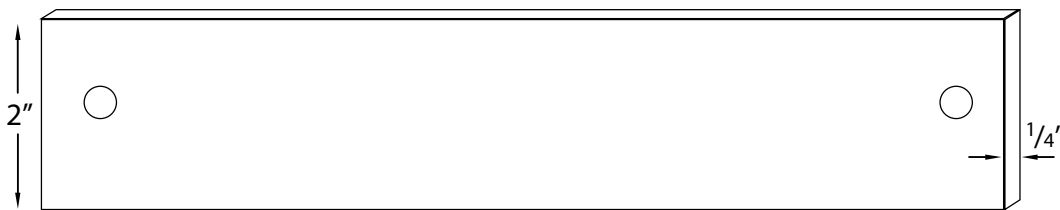

No. 105 Flat Track 250-400 lb. Capacity Pages 32-33



No. 102 Flat Track 800 lb. Capacity Pages 32-33